

1. Product Introduction

AH810 is a single chip programmable Hall effect linear sensor produced using advanced BCD technology. It includes a high sensitivity Hall sensor, high-precision Hall temperature compensation unit, Hall signal preamplifier, oscillator, dynamic offset elimination circuit, and amplifier output module. It can provide customers with more effective AC/DC current detection solutions and is widely used in communication, industrial, and consumer electronic devices.

AH810 adopts overcurrent protection with high bandwidth dynamic offset cancellation technology. In the absence of a magnetic field, the static output can be selected as 50% V_{CC} or a fixed value of 2.5V. The internally integrated dynamic imbalance elimination circuit ensures that the sensitivity of the IC is not affected by external pressure and IC packaging stress.

The output voltage of AH810 is proportional to the applied magnetic field strength, and customers can program on the power pin to adjust the chip sensitivity and static (zero field) output voltage, thereby improving product performance in the final application.

AH810 has a static output voltage adjustable range of 2.5V \pm 0.2V or 50% V_{CC} , and an output sensitivity adjustable range of 1.66~29.3mV/Gs.



2. Function

- Single chip programmable
- Accuracy (typical value): $\pm 1\text{mV}@25^\circ\text{C}$
- High linearity: $\pm 0.1\%@25^\circ\text{C}$;
- High bandwidth: 120kHz;
- Output response time: 4 μs (typical value);
- Stability within the working range: 1.5% $@25^\circ\text{C}\sim 150^\circ\text{C}$; 1% $@-40^\circ\text{C}\sim 25^\circ\text{C}$;
- 50% V_{CC} output or a fixed 2.5V output;
- Low noise analog signal path;
- Strong anti-interference ability;
- Strong resistance to mechanical stress, and the magnetic field parameters are not offset by external pressure;
- ESD(HBM): 5kV;
- Operating temperature: $-40^\circ\text{C}\sim 150^\circ\text{C}$;
- Passed RoHS certification: (EU) 2015/863。

3. Application

- Inverter current detection;
- Motor phase current detection (motor control);
- Solar inverter;
- Battery load detection system;
- Current transformer;
- Switching power supply;
- Overload protection device;

AH810

Hall Current Sensor



Alfa Electronics Co.,Ltd

4. Products packaging

Part No.	Sensitivity range	Packages	Packing
AH810-A	1.66~3.65mV/Gs	TO94	1000pcs/ bag
AH810-B	3.65~7.32mV/Gs	TO94	1000pcs/ bag
AH810-C	7.32~14.82mV/Gs	TO94	1000pcs/ bag
AH810-D	14.82~29.3mV/Gs	TO94	1000pcs/ bag

AH810

Hall Current Sensor



Alfa Electronics Co.,Ltd

Content

1.Product Introduction.....	1
2. Function	1
3. Application.....	1
4. Products packaging	2
5. Functional Block Diagram.....	4
6. Pin information	4
7. Output characteristics.....	5
8. Typical Application Circuit.....	5
9. Electromagnetic characteristics	6
10. Characteristic definition.....	9
11. Characteristic Performance	13
12. Ordering information	13
13. Package Material Information.....	14
14. Notes	15
15. Historical Version.....	15

5. Functional Block Diagram

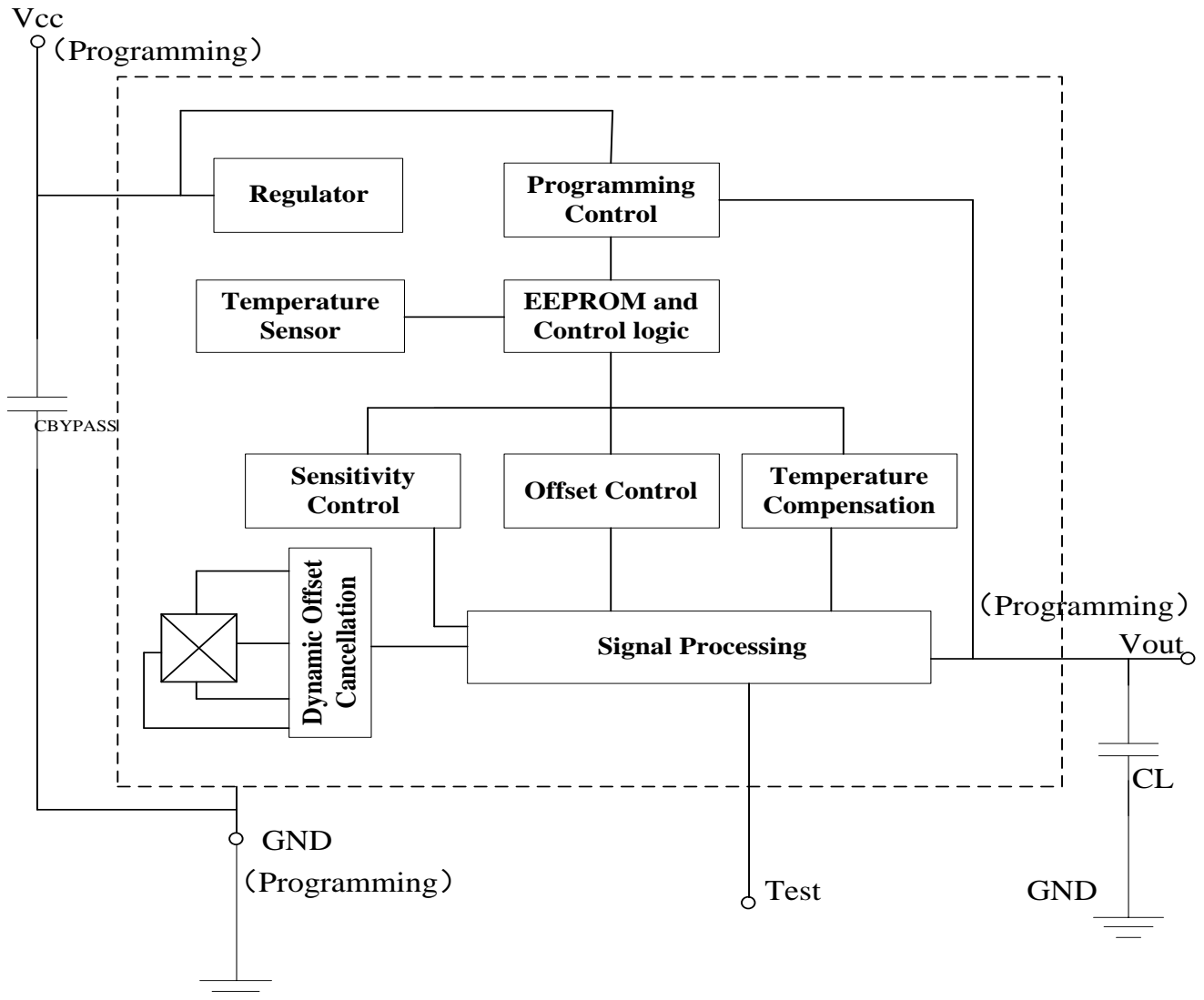

6. Pin information

No.	Name	Describe
1	V _{CC}	Power supply/programming pins
2	V _{OUT}	simulate output/ programming pins
3	TEST	Programming test pin/output 2.5V reference
4	GND	Grounding/programming pins

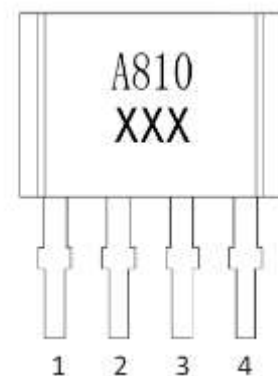

AH810

Hall Current Sensor



Alfa Electronics Co.,Ltd

7. Output characteristics

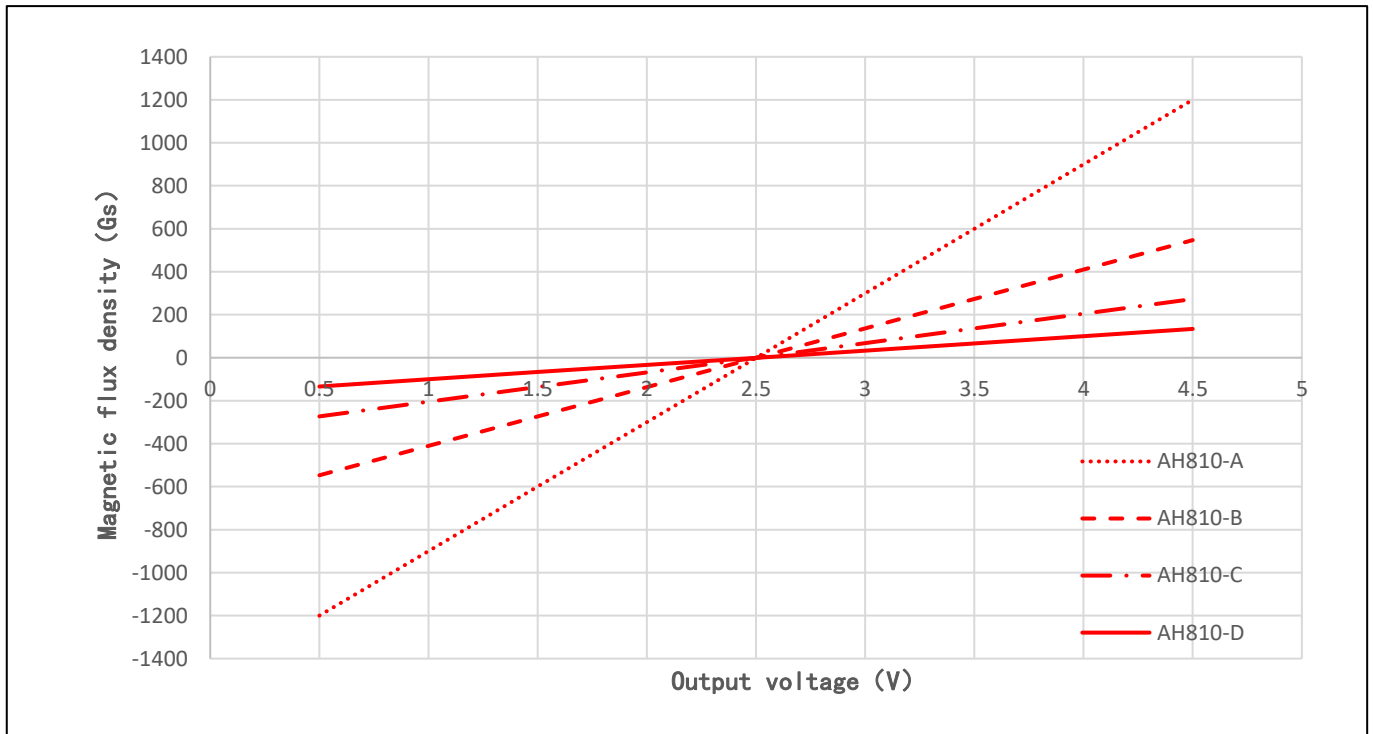

8. Typical Application Circuit

AH810 typical application circuit, C_L filter capacitor, C_P bypass capacitor

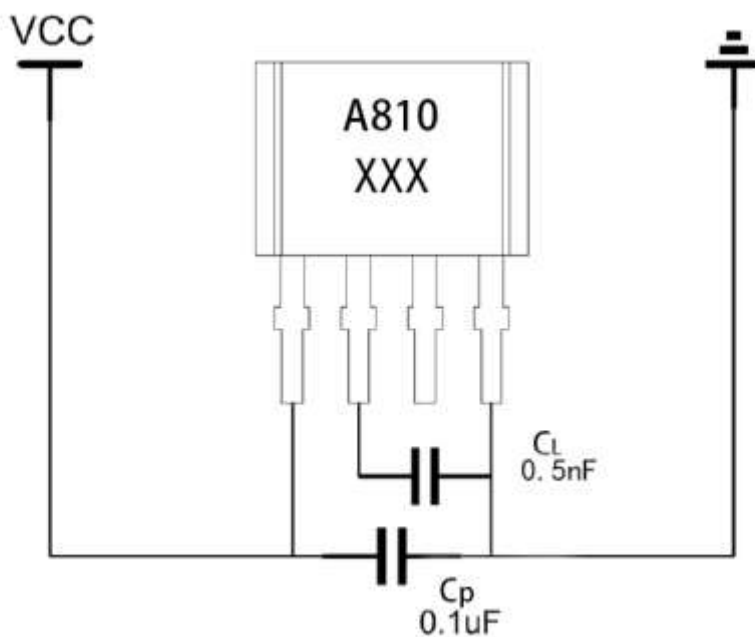

9. Electromagnetic characteristics

9.1 limit parameter

Exceeding the limit parameters during use can lead to unstable chip functionality, and prolonged exposure to this environment can damage the chip.

Symbol	Parameters	Min	Max	Unit
V _{CC}	Power supply current	-	6	V
V _{OUT}	Output voltage	-	V _{CC} +0.5	V
I _{OUT(source)}	Output current source	-	80	mA
I _{OUT(sink)}	Output current sink	-	40	mA
T _A	operating ambient temperature	-40	150	°C
T _S	storage temperature	-65	175	°C
T _J	maximum junction temperature	-	170	°C
Endurance	EEPROM	200	-	cycle

9.2ESD ratings

Symbol	Describe	Executive standcards	Max	Unit
V _{ESD}	HBM	JEDEC JS-001-2017	5	kV

9.3Electrical Parameters

Symbol	Parameters	Test condition	Min	Typ	Max	Unit
V _{CC}	Power supply current	-	4.5	5	5.5	V
I _{CC}	Power supply current	T _A =25°C, Output unloaded	9	11.4	13	mA
BW	Built in bandwidth	Small signal: -3dB, C _L =1nF, T _A =25°C	-	120	-	kHz
TPO	TPO	T _A =25°C, C _L =1nF, sensitivity 2mV/G, constant magnetic field: 400Gs	-	100	-	us
TTC	TTC	T _A =150°C, C _L =1nF, sensitivity 2mV/G, constant magnetic field: 400Gs	-	300	-	us
VUVLOH	Undervoltage-lockout threshold	T _A =25°C, The voltage rises and the device begins to operate	-	4.1	-	V



VUVLOL		$T_A=25^{\circ}\text{C}$, The voltage drops and the device stops operating		3.8		V
VPORH	Reset voltage	$T_A=25^{\circ}\text{C}$, V_{CC} rises	-	4.1	-	V
VPORL		$T_A=25^{\circ}\text{C}$, V_{CC} drops	-	3.8	-	V
tPORR	Power on reset release time	$T_A=25^{\circ}\text{C}$, V_{CC} rises	-	10	-	us
I_{SCLP}	Maximum current source	-	-	80	-	mA
I_{SCLN}	Maximum current sink	-	-	40	-	mA
V_{OL}	Analog output saturation low level	$R_L \geq 4.7\text{k}\Omega$	-	0.5	-	V
V_{OH}	Analog output saturation high level	$R_L \geq 4.7\text{k}\Omega$	$V_{CC}-0.3$	-	4.7	V
C_L	Output load capacitance	V_{OUT} to GND	-	0.5	1	nF
R_L	Output load resistance	V_{OUT} to GND		10	-	k Ω
		V_{OUT} to V_{CC}		10		k Ω
R_{OUT}	Output resistance	-		9		Ω
T_R	rise time	$T_A=25^{\circ}\text{C}$, constant magnetic field 400Gs, $C_L=1\text{nF}$, sensitivity 2mV/Gs	-	5.5	-	μs
TPD	transmission delay	$T_A=25^{\circ}\text{C}$, constant magnetic field 400Gs, $C_L=1\text{nF}$, sensitivity 2mV/Gs	-	4.5	-	μs
TRESP	response time	$T_A=25^{\circ}\text{C}$, constant magnetic field 400Gs, $C_L=1\text{nF}$, sensitivity 2mV/Gs	-	4	5	μs
VN	noise	$T_A=25^{\circ}\text{C}$, $C_L=1\text{nF}$, sensitivity 2mV/Gs, $B_{Wf}=B_{wi}$	-	14.1	-	mVp-p

9.4 Precision parameters

Symbol	Parameters	Test condition	Min	Typ	Max	Unit
LinERR	Linear sensitivity error		-0.1	$<\pm 0.05$	0.1	%
SymERR	symmetry sensitivity		-0.1	$<\pm 0.05$	0.1	



	error					
ERAT_VOQ	Static voltage output error	$V_{CC}=4.5$ to $5.5V$, $T_A=25^{\circ}C$	-	0.4	-	%
Δ SNST_PKG	Sensitivity drift (caused by packaging)	$T_A=25^{\circ}C$, Temperature cycling $25^{\circ}C$ to $150^{\circ}C$ and back to $25^{\circ}C$	-	± 1.25	-	%

9.5 programming parameters

Symbol	Parameters	Test condition	Min	Typ	Max	Unit
VOQT(Q)_init	Initially programmed static voltage output	$T_A=25^{\circ}C, V_{CC}=5V$	-	2.5	-	V
VOQ_PR	Static voltage output programming range	$T_A=25^{\circ}C, V_{CC}=5V$	2.3	-	2.7	V
VOQ_STEP	Average static voltage output step value	$T_A=25^{\circ}C, V_{CC}=5V$	-	2.38	-	mV
EVOQ_STEP	Static voltage output programming resolution	$T_A=25^{\circ}C, V_{CC}=5V$	-	$\pm 0.5 \times E_{VOQ_STEP}$	-	mV
SENS_INIT	Initial non programming sensitivity for each gear position	SENS_COARSE=001, $T_A=25^{\circ}C$	-	2.5	-	mV/Gs
		SENS_COARSE=000, $T_A=25^{\circ}C$	-	5	-	mV/Gs
		SENS_COARSE=111, $T_A=25^{\circ}C$	-	10	-	mV/Gs
		SENS_COARSE=110, $T_A=25^{\circ}C$	-	20	-	mV/Gs
SENS_PR	Sensitivity programming gear	SENS_COARSE=001, $T_A=25^{\circ}C$	1.80		3.65	mV/Gs
		SENS_COARSE=000, $T_A=25^{\circ}C$	3.65		7.32	mV/Gs
		SENS_COARSE=111, $T_A=25^{\circ}C$	7.32		14.82	mV/Gs
		SENS_COARSE=110, $T_A=25^{\circ}C$	14.82		30.00	mV/Gs
Sens_fine_step	Average fine sensitivity step value	SENS_COARSE=001, $T_A=25^{\circ}C$		7.5		μ V/Gs
		SENS_COARSE=000, $T_A=25^{\circ}C$		15		μ V/Gs

AH810

Hall Current Sensor



Alfa Electronics Co.,Ltd

		SENS_COARSE=111 ,T _A =25°C		30		μV/Gs
		SENS_COARSE=110 ,T _A =25°C		60		μV/Gs

9.6 factory-programmed static voltage output temperature coefficient

Symbol	Parameters	Test condition	Min	Typ	Max	Unit
ΔSensTC	Sensitivity drift of each temperature range	T _A =25°C to 150°C	-2.5		2.5	%
		T _A =-40°C to 25°C	-3		3	%
SENS_TC_STEP	Average sensitivity temperature compensation step value		-	0.23	-	%
ΔVOQ_TC	Static voltage output drift in different temperature ranges	T _A =150°C,T _A =-40°C,calculated relative to 25°C	-	0	-	mV/°C
StepQVOT _C	Average static voltage output temperature compensation step value		-	3.6	-	mV

9.7 programmed lock bits

EELOCK_BIT	EEPROM		-	1	-	Bit
------------	--------	--	---	---	---	-----

10. Characteristic definition

10.1 TPO

When the power supply rises to the operating voltage, the chip needs a limited time to power its internal components before it can react to the input magnetic field.

Power-on time: the time it takes for the power supply to reach the minimum working voltage VCCMIN is t1; In the case of an external magnetic field, the time it takes for the output to reach 90% of the stable value t2, the difference between the two is the power-on time.

AH810

Hall Current Sensor



Alfa Electronics Co.,Ltd

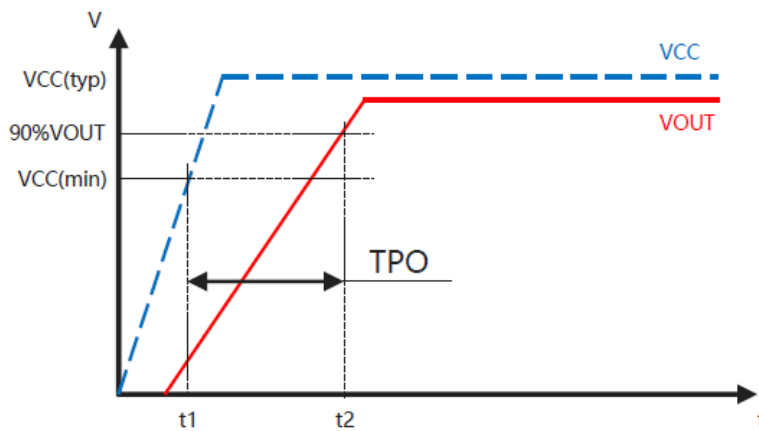

Figure 1: Power-on time definition

10.2 TTC

After power-on, temperature tune-up time is required before effective temperature compensation output.

10.3 TPD

The time difference between when the external magnetic field reaches 20% of the final value and when the output reaches 20% of the final value.

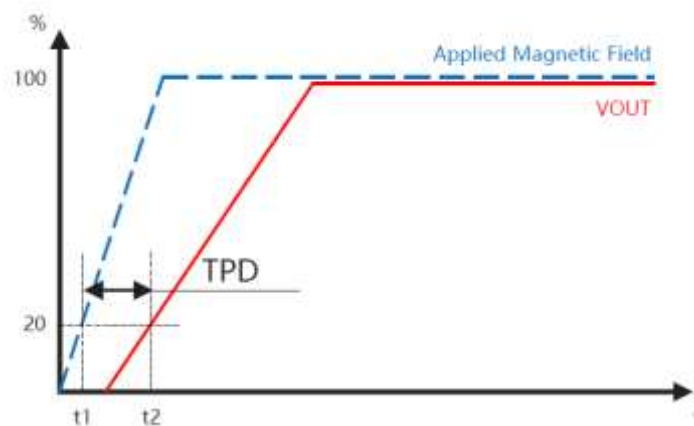

Figure 2: Transmission delay definition

10.4 TR

The time difference between the chip output level rising from 10% to 90%, both TR and TRESP are negatively affected from eddy currents if used to ground the conductive plane.

AH810

Hall Current Sensor



Alfa Electronics Co.,Ltd

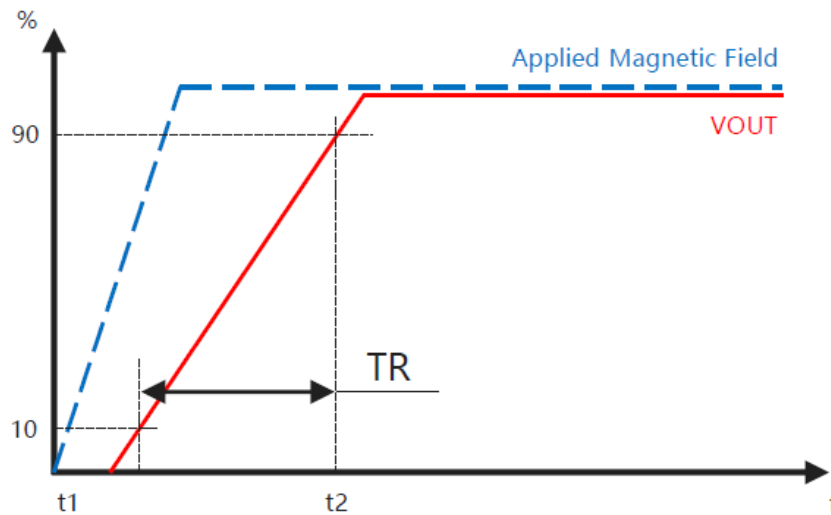

Figure 3: Rise time definition

10.5 TRESP

The time difference when the external magnetic field applied by the chip reaches 80% of the final value and the corresponding output value also reaches 80%. If the conductive plane grounding is used, both TR and TRESP will be negatively affected by eddy currents.

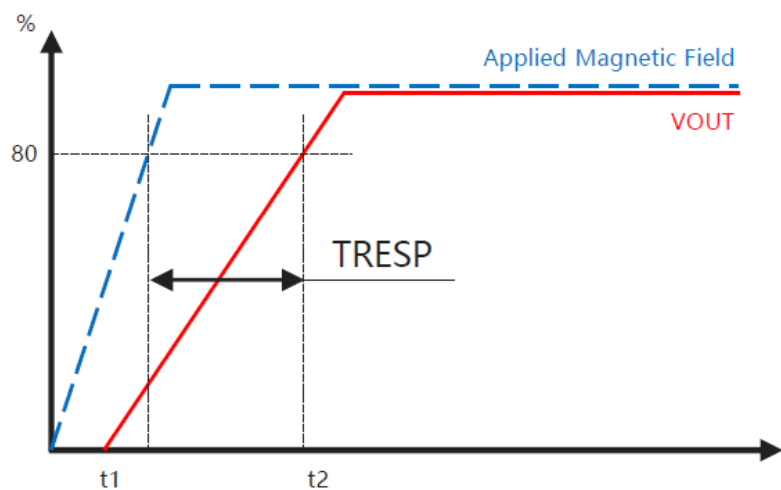

Figure 4: Response time definition

10.6 VOQ

The hall sensor supply voltage and ambient temperature in working range, magnetic field for 0Gs, chip output.

10.7 VOE

The difference between the actual output voltage of the sensor and the ideal output voltage supply when the magnetic field is zero. When the output voltage is fixed, the static voltage output error is the difference between the actual output error and the 2.5V voltage. In output mode proportional to the supply, the static voltage output error is the difference between the actual output error and $V_{CC}/2$.

10.8 Sens

Sensitivity indicates the change in the sensor output in mV/Gs for every 1 Gauss change in the magnetic field generated by the current being measured. The calculation method is as follows: the south magnetic field and the north magnetic field are respectively entered, and the difference of the sensor output voltage at 2 points is divided by the difference of the south magnetic field and the north magnetic field, that is, the sensitivity of the sensor. The specific calculation formula is as follows:

$$SENS = (V_{out}(GS_{max}) - V_{out}(GN_{max})) / (GS_{max} - GN_{max})$$

GS_{max} and GN_{max} are the south magnetic field and the north magnetic field respectively, and $V_{out}(GS_{max})$ and $V_{out}(GN_{max})$ are the analog output voltage of the sensor when it is moving towards the south magnetic field and the north magnetic field respectively.

10.9 ETOT

This error value represents the maximum error of the sensor in various environments, which is equal to the absolute value of the measurement error in each temperature range in the whole measurement range, divided by the maximum output dynamic range of the sensor. The details can be expressed as follows:

$$ETOT(IP) = \text{Max}(V_{OUT} - V_{OUT_idea}) / (V_{OUT}(IP_{max}) - V_{oq})$$

$\text{Max}(V_{out} - V_{out_idea})$ represents the maximum error within the measurement range, and $(V_{out}(IP_{max}) - V_{oq})$ represents the maximum output dynamic range of the sensor.

10.10 ELIN

Because the sensor is not ideal, the output voltage of the sensor and the measured magnetic field are not completely linear in practical application. After linear fitting by least square method, the maximum output error of the sensor divided by the dynamic range of the sensor is the linear error of the sensor.

$$ELIN (IP) = \Delta V_{out} / (V_{out}(IP_{max}) - V_{oq})$$

AH810

Hall Current Sensor



Alfa Electronics Co.,Ltd

ΔV_{out} is the maximum linear error in the measurement range of the sensor.

11. Characteristic Performance

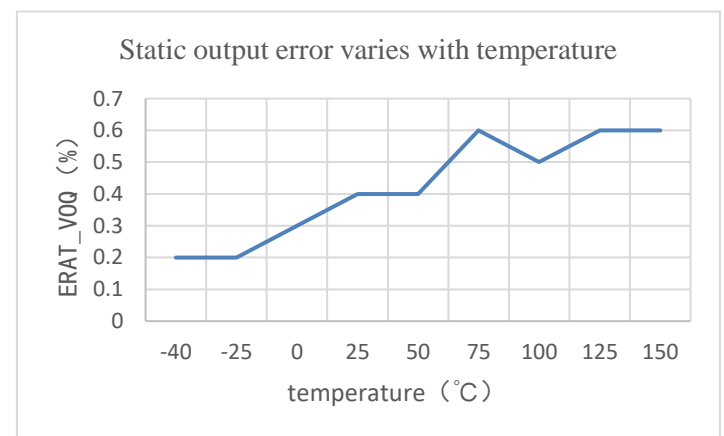
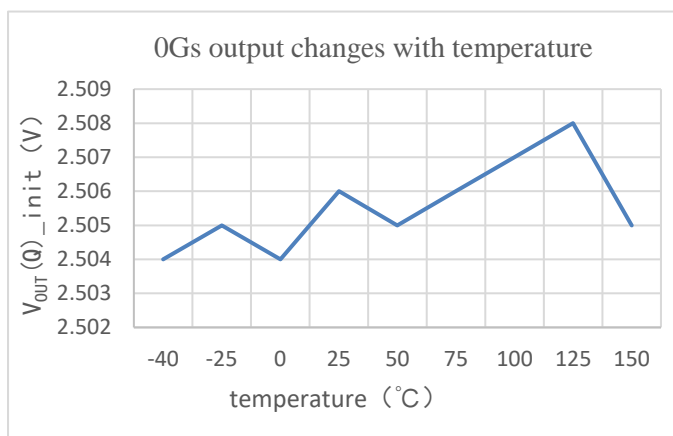
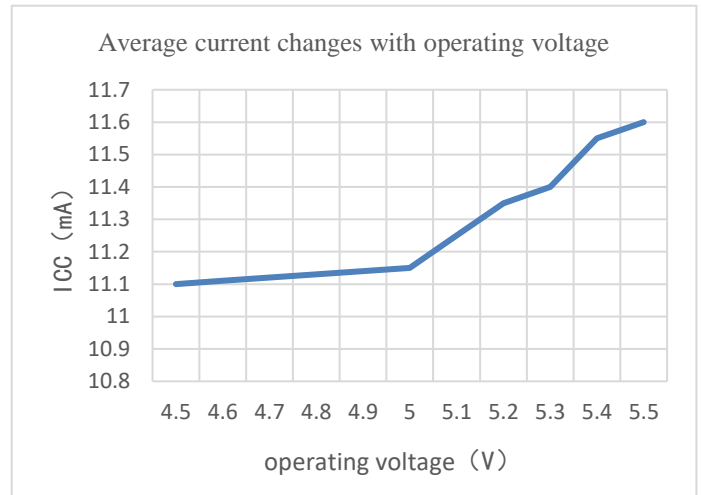
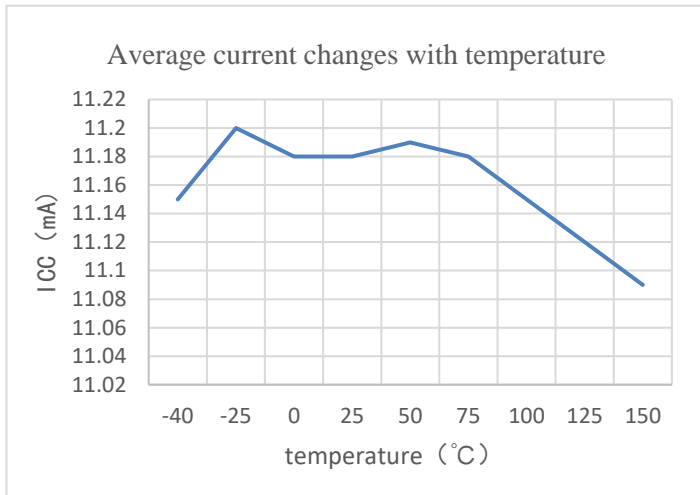

12. Ordering information

No.	Packages	Packing	temperature range
AH810-A	TO94	1000/ bag	-40°C~150°C
AH810-B	TO94	1000/ bag	-40°C~150°C
AH810-C	TO94	1000/ bag	-40°C~150°C
AH810-D	TO94	1000/ bag	-40°C~150°C

AH810

Hall Current Sensor



Alfa Electronics Co.,Ltd

13. Package Material Information

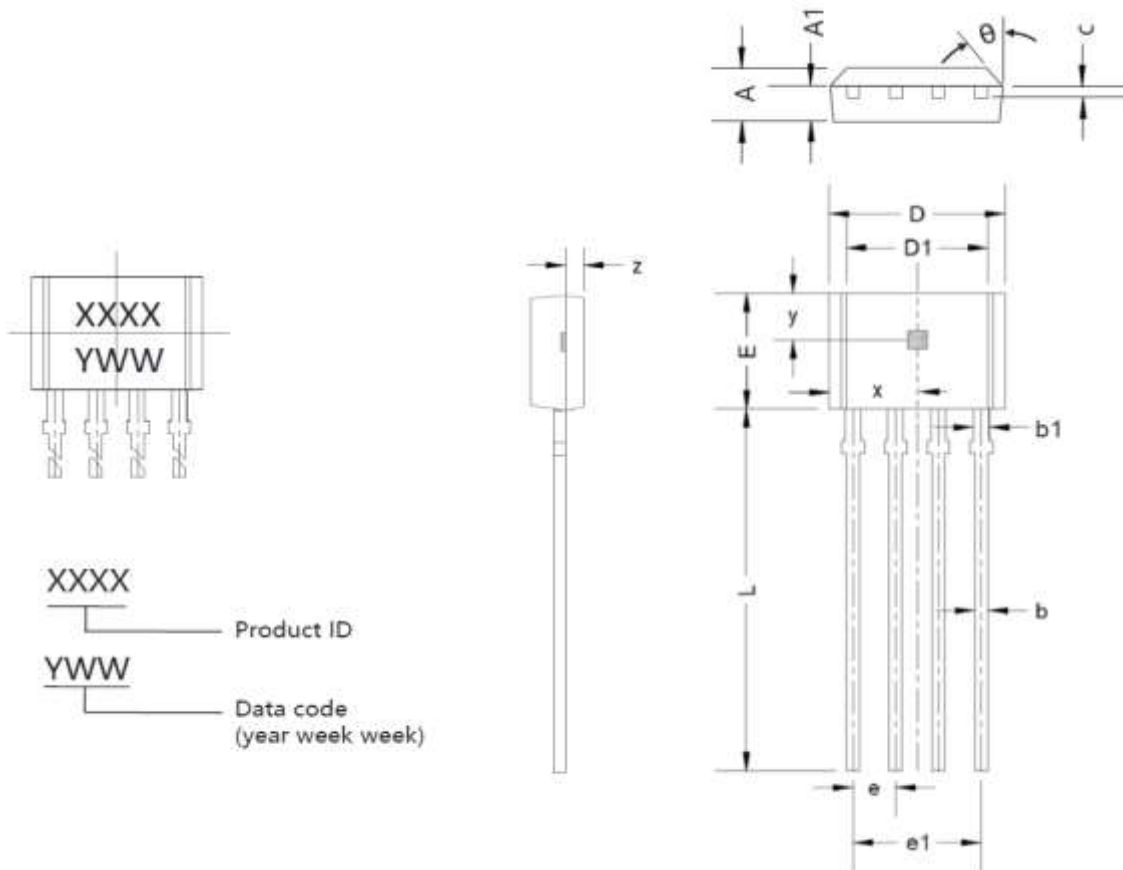

Symbol	Dimensions in Millimeters		Dimensions in Inches	
	Min	Max	Min	Max
A	1.400	1.800	0.055	0.071
A1	0.700	0.900	0.028	0.035
b	0.360	0.500	0.014	0.020
b1	0.380	0.550	0.015	0.022
c	0.360	0.510	0.014	0.020
D	4.980	5.280	0.196	0.208
D1	3.780	4.080	0.149	0.161
E	3.450	3.750	0.136	0.148
e	1.270(BSC)		0.050(BSC)	
e1	3.710	3.910	0.146	0.154
L	14.900	15.300	0.587	0.602

AH810

Hall Current Sensor



Alfa Electronics Co.,Ltd

x	2.565(BSC)	0.101(BSC)
y	1.170(BSC)	0.046(BSC)
z	0.500(BSC)	0.020(BSC)
θ	45°	45°

14. Notes

- Hall chips are sensitive devices, and electrostatic protection measures should be taken during use, installation, and storage.
- During installation and use, mechanical stress applied to the device casing and leads should be minimized as much as possible.
- It is recommended that the welding temperature should not exceed 350 °C and the duration should not exceed 5 seconds.
- To ensure the safety and stability of Hall chips, it is not recommended to use them beyond the parameter range for a long time.

15. Historical Version

No.	Time	Describe
1	September 6th, 2022	Update Characteristic Performance
2	December 22th, 2022	Update static voltage output error range
3	February 9th, 2023	Update IC limit of operate temperature and storage temperature
4	April 10th, 2023	Version update to V1.2

AH810

Hall Current Sensor



Alfa Electronics Co., Ltd

Copyright ©2018, Alfa Electronics Co., Ltd

Alfa Electronics Co., Ltd reserves the right to make, from time to time, such departures from the detail specifications as may be required to permit improvements in the performance, reliability, or manufacturability of its products. Before placing an order, the user is cautioned to verify that the information being relied upon is current.

Alfa's products are not to be used in any devices or systems, including but not limited to life support devices or systems, in which a failure of Alfa's product can reasonably be expected to cause bodily harm.

The information included herein is believed to be accurate and reliable. However, Alfa Electronics Co., Ltd assumes no responsibility for its use; nor for any infringement of patents or other rights of third parties which may result from its use.